

12mm + 1mm IXPE Attached Pad Laminate Installation Instructions

Thank you for choosing our product. When properly installed and cared for, your new flooring will be easy to maintain and will keep its great look for years.

WARNING! DO NOT SAND, DRY SWEEP, DRY SCRAPE, DRILL, SAW, BEAD-BLAST OR MECHANICALLY CHIP OR PULVERIZE EXISTING RESILIENT FLOORING, BACKING, LINING FELT, ASPHALTIC "CUTBACK" ADHESIVES OR OTHER ADHESIVES.

These products may contain either asbestos fibers and/or crystalline silica. Avoid creating dust. Inhalation of such dust is a cancer and respiratory tract hazard. Smoking by individuals exposed to asbestos fibers greatly increases the risk of serious bodily harm. Unless positively certain that the product is a non-asbestos-containing material, you must presume it contains asbestos. Regulations may require that the material be tested to determine asbestos content and may govern the removal and disposal of material.

See current edition of the Resilient Floor Covering Institute (RFCI) publication Recommended Work Practices for Removal of Resilient Floor Coverings for detailed information and instructions on removing all resilient covering structures.

Please read all the instructions before you begin the installation. Improper installation will void warranty.

I. GENERAL PREPARATIONS

IMPORTANT NOTICE

After installation, make sure that the flooring is not be exposed to temperatures less than 0°F (-15°C) or greater than 140°F (60°C).

It is preferable to lay boards following the direction of the main source of light. For the best result, make sure to always work from 2 to 3 cartons at a time, mixing the planks during the installation.

TOOLS REQUIRED: Spacers, rubber mallet, ruler, pencil, tape measure, & saw.

- Prior to installation, inspect material in daylight for visible faults/damage. No claims on surface defects will be accepted after installation.
- Check if subfloor/site conditions comply with the specifications described in these instructions. If you are not satisfied, do not install, and contact your supplier.
- Flooring products can be damaged by rough handling before installation. Exercise care when handling and transporting these products. Store, transport and handle the flooring planks in a manner to prevent any damage. Store cartons flat, never on edge.
- Flooring products can be heavy and bulky. Always use proper lifting techniques when handling these products. Whenever possible, make use of material-handling equipment such as dollies or material carts. Never lift more than you can safely handle; get assistance.
- Calculate the room surface prior to installation and plan an extra 5%-10% of flooring for cutting waste.
- The environment where the flooring is to be installed is critically important with regard to successful installation and continued performance of the flooring products. The flooring is intended to be installed in interior locations only. These interior locations must meet climatic and structural requirements as well.
- Flooring should only be installed in temperature-controlled environments. It is necessary to maintain a constant temperature before, during and after the installation. Portable heaters are not recommended as they may not heat the room and subfloor sufficiently. Kerosene heaters should never be used.
- This product should be acclimated for a minimum of 24 hours in sealed un-opened cartons.
- For floor surfaces exceeding 6400ft² (620m²) and/or lengths exceeding 80 lineal feet (25m), use expansion moldings.

II. SUBFLOOR INFORMATION

- Inspect your subfloor before you begin, it must be clean, dry and level to 3/16" (5mm) within 10 feet (3 meters). Substrates must be free from excessive moisture or alkali. Remove dirt, paint, varnish, wax, oils, solvents, any foreign matter and contaminates.
- Do not use products containing petroleum, solvents, or citrus oils to prepare substrates as they can cause staining and expansion of the new flooring.
- Although this floor is water resistant, it is not aimed to be used as a moisture barrier. The subfloor must be dry. Concrete moisture vapor emissions should not exceed 8lbs ASTM F1869 or 90%RH (ASTM F2170) with a PH limit of 9. A 6 mil polyfilm is required over all surfaces.
- This product is also not to be installed in areas that have a risk of flooding such as saunas or outdoor areas.

IMPORTANT NOTICE

Radiant Heat: Radiant heat systems must be embedded a minimum of 1/2" from the product. Maximum operating temperature should never exceed 85°F (30°C). Use of an in-floor temperature sensor is recommended to avoid overheating.

- Turn the heat off for 24 hours before, during and 24 hours after installation when installing over radiant heated subfloors.
- Before installing over newly constructed radiant heat systems, operate the system at maximum capacity to force any residual moisture from the cementitious topping of the radiant heat system. Concrete moisture vapor emissions should not exceed 8lbs ASTM F1869 or 90%RH (ASTM F2170) with a PH limit of 9.
- A 6 mil polyfilm is required underneath the laminate floor.
- Make sure that the temperature in the room is at least 60°F (15°C) during installation.
- Floor temperature must not exceed 85°F (30°C).
- Once the installation has been completed, the heating system should be turned on and increased gradually (5 degree increments) until returning to normal operating conditions.
- Refer to the radiant heat system's manufacturer recommendations for additional guidance.
- Warning: Electric heating mats that are not embedded into the subfloor are not recommended for use underneath the floors. Using electric heating mats that are not embedded and applied directly underneath the floors could void the warranty for your floor in case of failure. It is best to install the flooring over embedded radiant floor heating systems and adhere to the guidelines listed above.

WOOD SUBFLOORS

- If this flooring is intended to be installed over an existing wooden floor, it is recommended to repair any loose boards or squeaks before you begin the installation.
- Nail or screw every 6" (15 cm) along joists to avoid squeaking.
- Basements and crawl spaces must be dry. Use of a 6-mil black polyethylene is required to cover 100% of the crawl space earth.
- We recommend laying the floor crossways to the joists.
- All other subfloors - Plywood, OSB, particleboard, chipboard, wafer board, etc. must be structurally sound and must be installed following their manufacturer's recommendations.

CONCRETE SUBFLOORS

- Floors must be fully cured, at least 60 days old, smooth, permanently dry, clean, and free of all foreign material such as dust, wax, solvents, paint, grease, oils, and old adhesive residue. Curing agents and hardeners could cause bonding failure and should not be used.
- Depressions, deep grooves, expansion joints and other subfloor imperfections must be filled with patching & leveling compound.
- Concrete substrates must be flat within 1/8 of an inch (3mm) within a 6-foot (2 meters) radius, or 3/16 of an inch (5mm) within a 10-foot radius (3 meters). The substrate should not slope more than 1 inch (2.5cm) per 6 feet (2 meters) in any direction.
- Moisture and alkalinity tests should be performed on all concrete substrates regardless of grade level or age of slab. Perform either ASTM F2170 In-Situ Relative Humidity (RH) test or ASTM F1869 Calcium Chloride Moisture Test (MVER: Moisture Vapor Emission Rating). Perform pH test per ASTM F710 to determine alkalinity of the slab.
- Concrete moisture vapor emissions should not exceed 8lbs ASTM F1869 or 90%RH (ASTM F2170) with a PH limit of 9.
- A 6 mil polyfilm is required underneath the laminate floor.
- The Limited Warranty does not cover discoloration from mold or from flooding, floods, leaking plumbing or appliances, water entering through sliding glass doorways, as well as floor covering failure due to hydrostatic pressure or moisture vapor emission.

EXISTING FLOORS

- The flooring can be installed over most existing hard surface floor coverings, provided that the existing floor surface is clean, flat, dry, securely fastened, and structurally sound.
- Existing sheet vinyl floors should not be heavily cushioned and not exceed more than one layer in thickness. Soft underlayment and soft substrates will diminish the products inherent strength in resisting indentations.
- Never use solvents or citrus adhesive removers to remove old adhesive residue. Solvent residue left in and on the subfloor may affect the new floor covering.

DO NOT INSTALL OVER

- Existing Hardwood flooring and/or wood subfloors that lay directly on concrete or over dimensional lumber or plywood used over concrete.
- Any type of carpet.
- Existing cushion-backed flooring.
- Floating floor of any type, loose lay, and perimeter fastened sheet vinyl.

III. INSTALLATION

- Remove baseboard, quarter-round moldings, wall base, appliances, and furniture from room. For best results, door trim should be under-cut to allow flooring to move freely without being pinched. After preparation work, sweep and vacuum the entire work area to remove all dust and debris.
- With a floating floor you must always ensure you leave a 3/8" (8mm) gap between walls and fixtures such as pipes and pillars, stairs, etc. These gaps will be covered with trim moldings after the floor is installed.
Tip: When installing around pipes, drill the holes 3/4" (18mm) larger than the diameter of the pipes.
- Whenever possible, plan the layout so that the joints in the planks do not fall on top of joints or seams in the existing substrate. The end joints of the planks should be staggered a minimum of 8" (20.32 cm) apart. Do not install over expansion joints. Avoid installing pieces shorter than 12" (30 cm) at beginning or end of rows.
- Do not install your kitchen cabinets directly over your floor. The floor's quality can be guaranteed as long as the floor can move freely.
- Decide the installation direction. It is recommended to install the length direction of the planks parallel to the main light direction.
- Measure the area to be installed: The board width of the last row shall not be less than 2" (50mm). If so, adjust the width of the first row to be installed. In narrow hallways, it is recommended to install the floor parallel to the length of the hall.

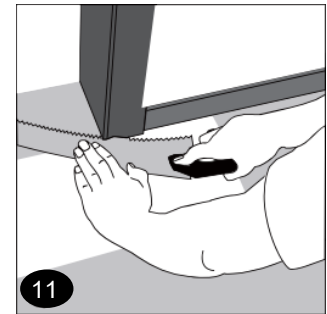
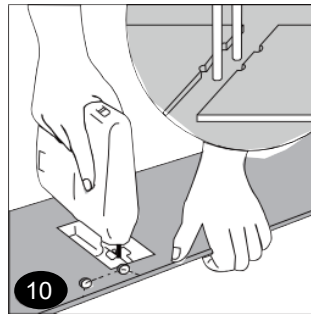
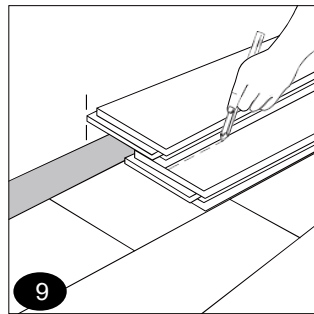
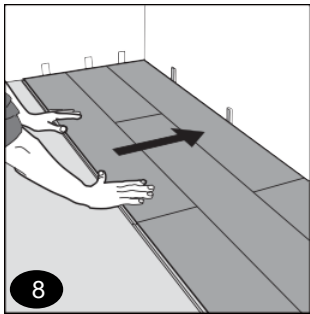
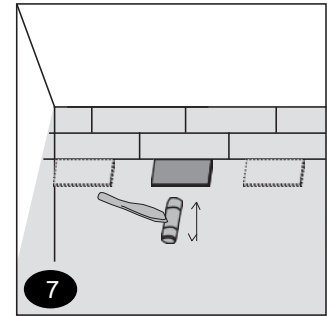
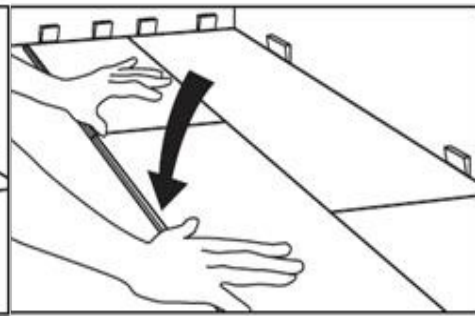
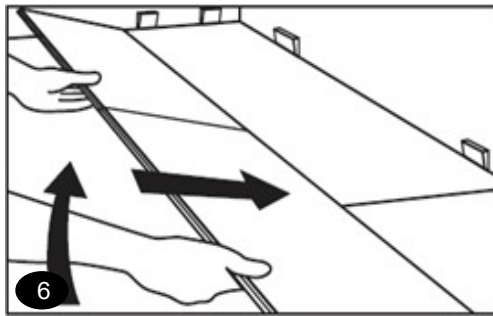
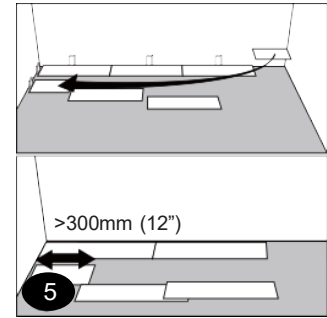
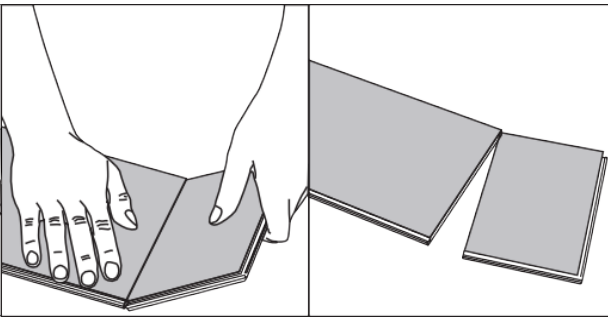
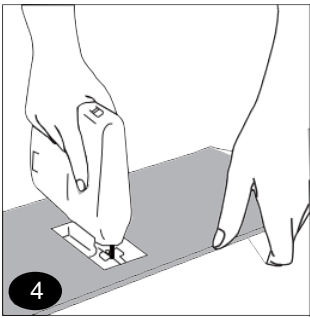
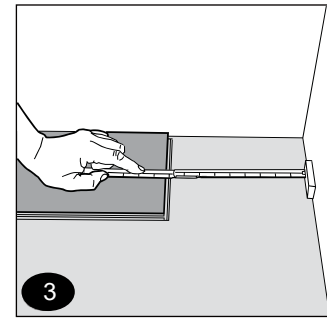
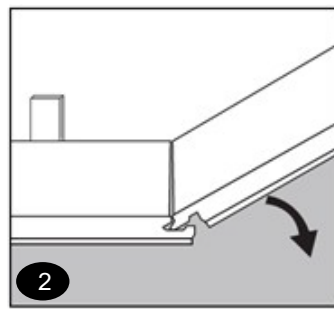
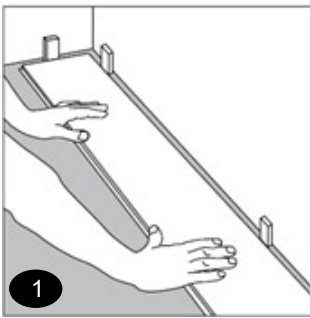

- 1) After thoroughly cleaning the subfloor, you should begin laying from left to right. Position the first plank so that grooved edge is facing you cutting off the tongue edge. Place the floorboard 3/8" (8mm) from the left wall. Use spacers between the wall and the floorboard.
- 2) Align the second plank of the first row against the end joint of the first plank of the first row at a slight angle and fold down until joints lock. Make sure that the click system is engaged tightly. Any gapping can compromise the integrity of the installation.
- 3) At the end of the first row, leave an expansion gap of 3/8" (8mm) to the wall and measure the length of the last plank to fit.
- 4) To cut the plank, use a saw with the board facing up.
- 5) Start the second row with the leftover cut plank from the previous row. This small plank should measure at least 12" (30cm), if it does not then a new plank will need to be cut in half and used to begin the second row. The end joints of each adjoining row should not be closer than 8" (20cm) to each other. Whenever practical, use the piece cut from the preceding row to start the next row. End joints of all planks should be staggered 6" or more.
- 6) Raise the long edge of the plank upward approximately 1" as shown above. Maintain this angle as you push the plank in until the long edge of the plank meets the long edge of the first row. Rotate downward on the plank until the joint locks. Gently tap the long side and short side joints closed, if necessary, using your scrap piece and tapping block.

7) **Helpful Hint**

After finishing the installation of every row, use scrap pieces and a small hammer or rubber mallet to gently tap the planks into the click of the previous row to make sure they are tightly clicked together and make sure there is no gap between the long side of the planks installed.

- 8) Continue this pattern until the first three rows are complete. After the first 3 rows are installed, check to ensure that the flooring is running parallel to room. If it is not, it could be that the starting wall has some irregularities. If so, the starting row of planks may have to be scribed and re-trimmed to account for any unevenness in the wall. This can be done without having to disassemble the beginning rows.
- 9) To lay the last row: position a loose board exactly on top of the last row laid. Place another board on top, with the tongue side touching the wall. Draw a line along the edge of this board, to mark the first board. Cut along the edge of this board to mark the first board. Cut along this line to obtain the required width. Insert this cut board against the wall. The last row should be at least 2" (50mm) wide. The spacers can then be removed.
- 10) Holes for pipes: measure the diameter of the pipe and drill a hole that is 3/4" (18mm) larger. Saw off a piece as shown in the figure and lay the board in place on the floor. Then lay the sawed-off piece in place.
- 11) Door molding and skirting: lay a board (with the decorative side down) next to the door molding and as saw shown in the figure. Then slide the floorboard under molding.
- 12) If it becomes necessary to separate planks already installed, separate the whole row by lifting it up delicately at an angle. To separate the end joints, place the planks flat on the subfloor and slide them apart.

FINISHING THE INSTALLATION

Seal perimeter edges with a bead of silicone-based sealant in damp areas including but not limited to bathrooms, kitchens, laundry rooms or any other high moisture areas. Replace molding or wall base, allowing slight clearance between the molding and the planks. Nail the molding to the wall surface, not through the flooring. At doorways and at other areas where the flooring planks may meet other flooring surfaces, it is preferable to use a "T" molding, or similar, to cover the exposed edge but not pinch the planks. Leave a small gap between the planks and the adjoining surface.

IV. INSTALLATION

- Sweep or vacuum daily using soft bristle attachments.
- Clean up spills and excessive liquids immediately.
- Damp mop as needed and use cleaners recommended for laminate flooring.
- Use proper floor protection devices such as felt protectors under furniture.
- Place a walk-off mat at outside entrances to reduce the amount of dirt brought into your home. Do not use mats with a latex or rubber backing since these backings can cause permanent discoloration.
- Do not use abrasive cleaners, bleach or wax to maintain the floor.
- Do not drag or slide heavy objects across the floor.

PREVENTIVE CARE

- When moving appliances or heavy furniture it is always wise to lay a plywood panel, or similar, on your floor and "walk" the item across it. This protects your floor from scuffing, gouging and tears.
- Frequently moved furniture should be equipped with felt pads to avoid scratching the floor. Heavy furniture and appliances should be equipped with non-staining large surface floor protectors. Furniture with castors or wheels must be easy swiveling, large surface non-staining and suitable for resilient floors. Do NOT use ball type castors as they can damage the floor.
- Caster wheeled chairs should have wide, rubber casters. Place protective mats under of office chairs.
- Use floor protectors under furniture to reduce indentation. As a general rule of thumb, the heavier the item, the wider the floor protector needed.
- Bathmats should be removed from flooring to fully dry after each use.